

## Success story



New product:

Shaft generator

# / MOTRAC: shaft generator

Creating a local grid with reduced fuel consumption

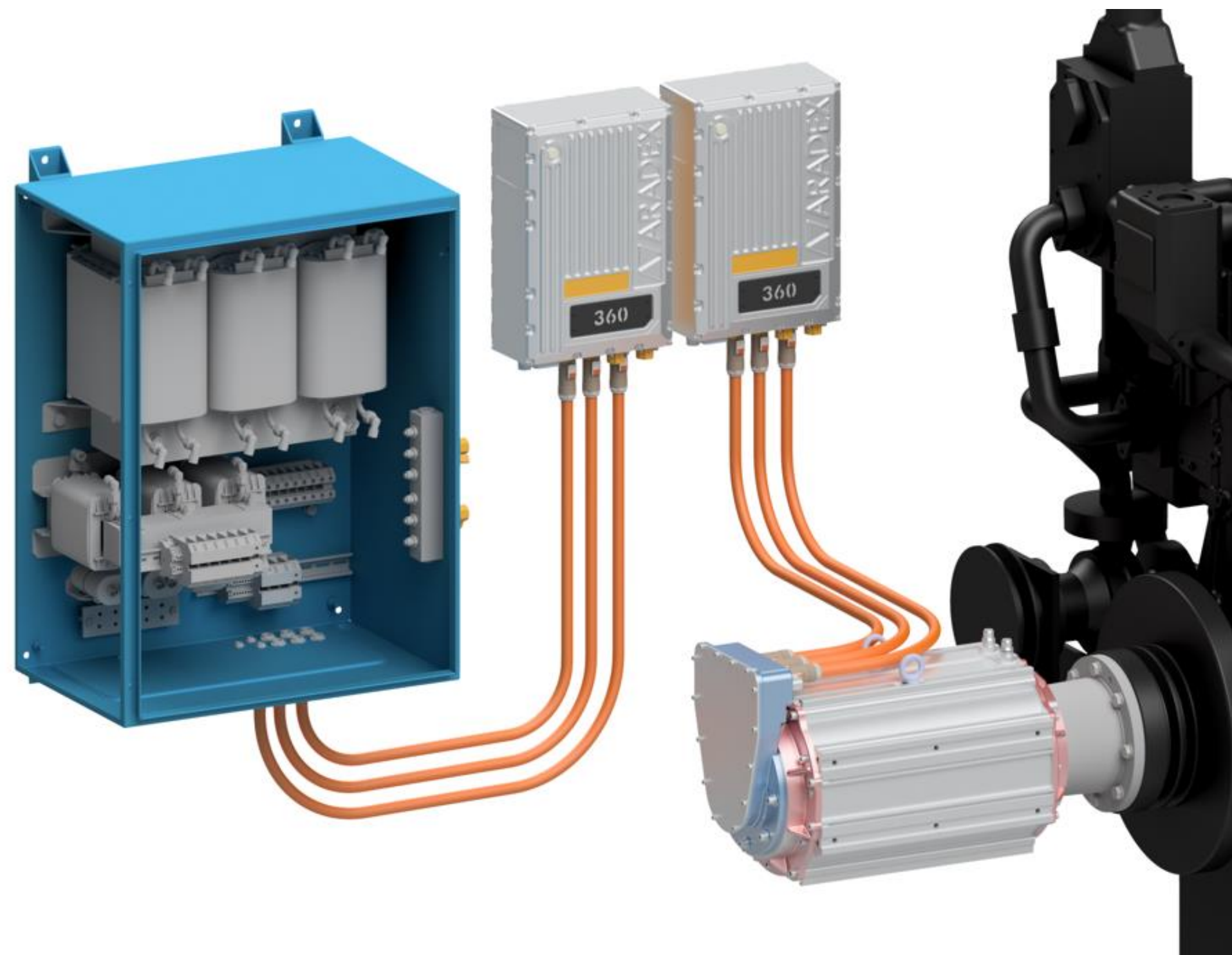

## **MOTRAC shaft generator, key-facts:**

- ❖ Main application: Shaft generator can be used with a power split, coupled to a propeller drive of the ship thus eliminating a separate operating genset and reducing the fuel consumption
- ❖ 55 kVA, 86 kVA versions are already available
- ❖ When a 55 kVA genset is replaced by the shaft generator a fuel saving of about 100 liters diesel per day can be expected

## **Advantages for MOTRAC using ARADEX products**

- ❖ ARADEX covers all key-HV-parts to realize a wide range of applications.
- ❖ These parts include transformers, filters and software to create local grids and to synchronize local grids to boost traditional gensets.
- ❖ The powerful tools enable us to realize even complex projects by our own engineers

# / MOTRAC: shaft generator

## Block diagram

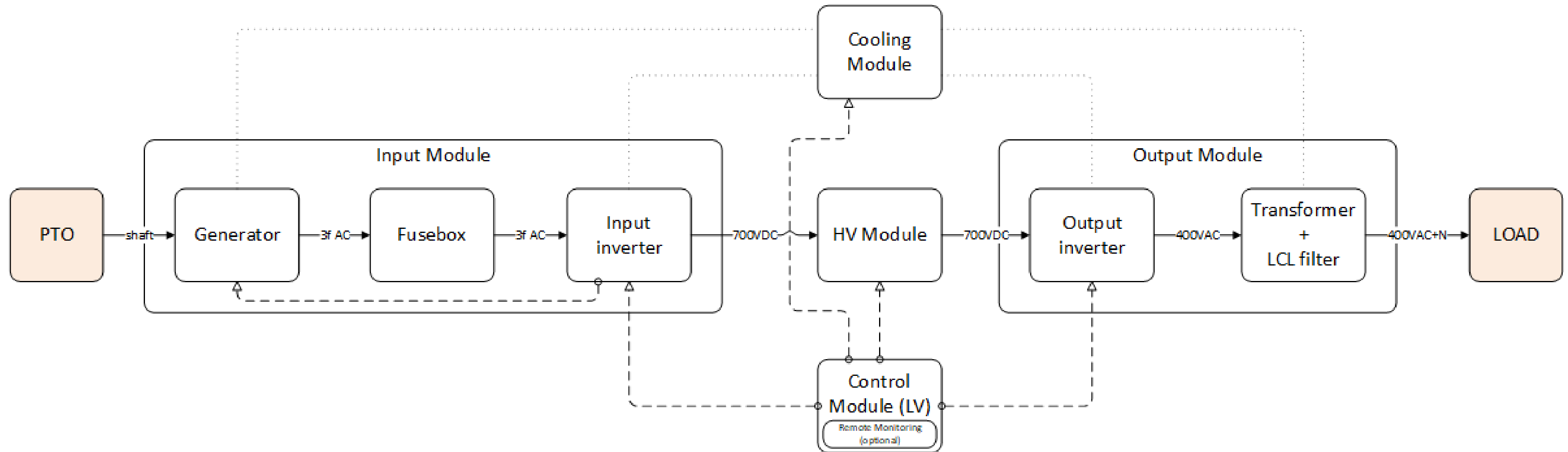

# / ARADEX's contribution to this project

Hardware, software, tools

## HARDWARE

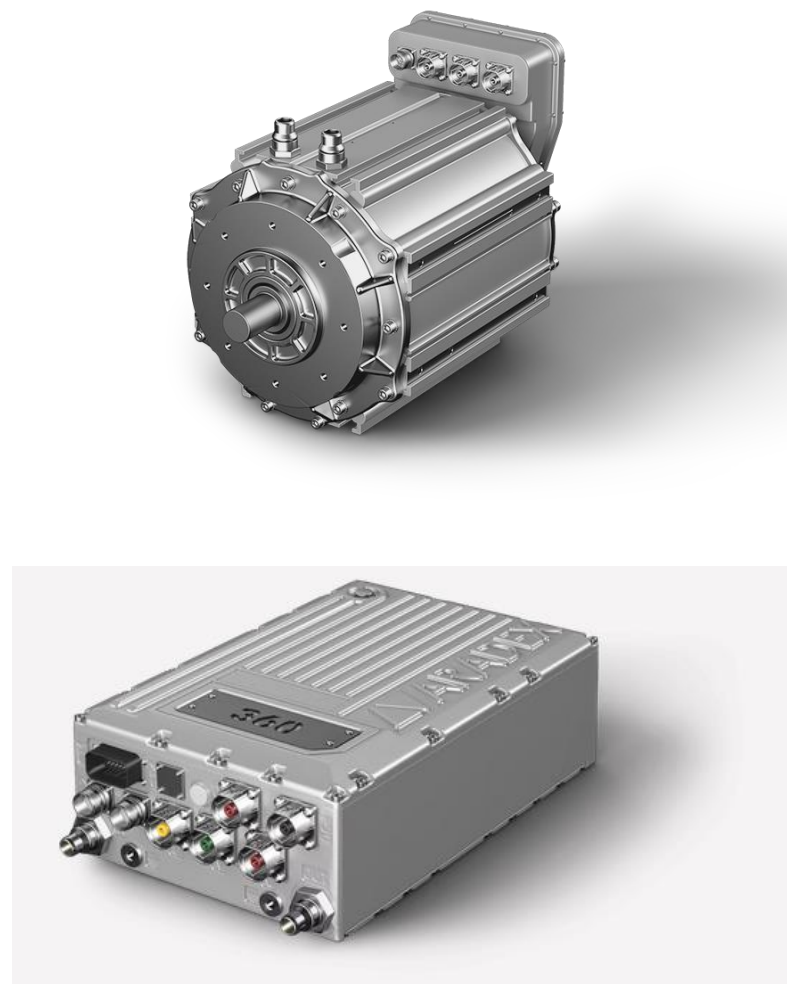

- E-motor
- Inverters
- Filters and transformer

## INTEGRATED SPS FUNCTION



- Sophisticated real-time PLC
- For function and diagnostics
- Your know-how, your USPs

## TOOLS

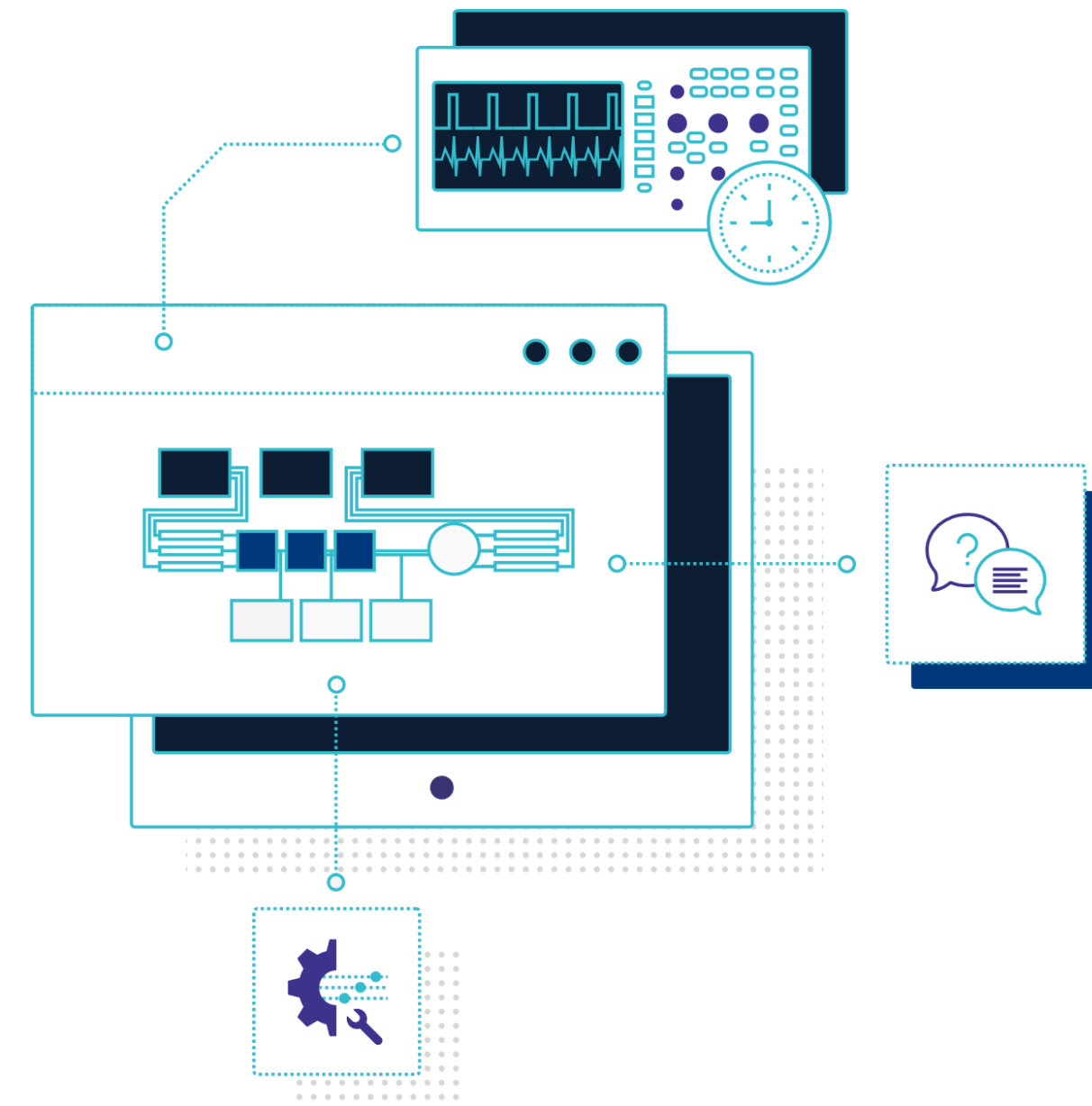



- Programming
- Parameterization
- Oscilloscope function



Challenge us with your application!

**Proven added-value  
mobile drive technology**



-  Ziegelwaldstr. 3, D-73547 Lorch, Germany
-  [Sales@aradex.com](mailto:Sales@aradex.com) | [Vertrieb@aradex.com](mailto:Vertrieb@aradex.com)
-  +49 / (0)7172 / 9181-0