



The illustration may contain optional equipment, Copyright: ARADEX AG

Datasheet VP5000-DCDC200

Art.-No: VP5000-DC18W140-68.1.22.01.80.0

VP5000 - Expert Solutions

Complete solutions for power components such as traction inverter, DC/DC converters, battery connections, onboard power supplies, generators or charging devices – including ARADEX technology and control modules as well as comprehensive application modules for easy system integration.

VP5000 DC/DC Features

- Excellent efficiency up to 98,5 %, even in low partial load
- Minimum voltage ripple due to the DC/DC converter for an optimal operation of batteries and supercapacitors
- Superior system can be configured regardless of the battery or supercapacitor type

ARADEX is your partner for exceptional solutions in electric drive technology.

Challenge us with your application:
Sales@aradex.com



General	
product name	VP5000-DCDC200
Article no.	VP5000-DC18W140-68.1.22.01.80.0
product version	1

Size	
Height (basic housing)	271 mm
Width (basic housing)	529 mm
Depth (basic housing)	414 mm
Weight	79 kg

Technical data	
Min. voltage DC-link [V DC]	48 V
Max. voltage DC-link [V DC]	770 V
Recommended voltage DC-link	650 V
DC-link shutdown threshold level 1	800 V
DC-link shutdown threshold level 2	820 V
Integrated DC link capacity	300 μ F
Integrated capacity DC output	800 μ F
Min. voltage DC output	20 V
Max. voltage DC output	Input - 20 V
Continuous current 1 DC ¹⁾	400 A
Continuous current 2 DC ²⁾	350 A
Continuous power at output ⁴⁾	200 kW
Peak power at output for 30sec ³⁾	240 kW
DC Controller voltage max.	28 V
Technical notes	¹⁾ Continuous current output at 650VDC, 30l/min coolant flow rate at 35°C and 45°C ambient temperature ²⁾ Continuous current output at 650VDC, 30l/min coolant flow rate at 65°C and 45°C ambient temperature ³⁾ Peak current at 650VDC, 30l/min coolant flow rate at 35°C and 45°C ambient temperature ⁴⁾ Continuous power output at 610V - 660VDC, 30l/min coolant flow rate at 65°C and 45°C ambient temperature 580V - 660VDC, 30l/min coolant flow rate at 35°C and 45°C ambient temperature

Interfaces	
Communication bus	● CAN
Analogue inputs	2
Digital inputs	2

Interfaces

Digital outputs (each 0,2A)	2
-----------------------------	---

Environment

Min. ambient temperature in operation	-25 °C
Max. ambient temperature in operation	45 °C
Max. ambient temperature in operation with derating	75 °C
Protection class according to EN 60529	IP65
Humidity according to IEC 60068-2-35	max. 90%, noncondensing
Max. altitude of site above sea level	2000 m
Polution degree according to DIN EN 61800	2, inside space

Cooling

Liquid cooling	yes
Max. coolant temperature without derating	35 °C
Min. coolant throughput	30 l / min
Max. coolant throughput	40 l / min
Pressure difference typical	0.4 bar
Min. coolant pressure	0.5 bar
Max. coolant pressure	2 bar

Pin settings

ST1

Properties

Plug type	AMPSEAL HDR SNAP IN W/G 23pol.
Plug design	Gehäusevariante WF

Pin no.	Description	Function	I/O
1	KL 31	Logic supply voltage, DC GND	Input
2	KL 30b	Logic supply voltage, DC +	Input
3	Enable	Enabling power Output	Input
4	Digi Out1	Digital output 1	Output
5	Digi Out2	Digital output 2	Output
6	NTC1	NTC temperature sensor no.1	Input
7	NTC2	NTC temperature sensor no.2	Input
8	AN_I1+	Analog current input no. 1 +	Input
9	CAN_L	Can Bus low	bidirectional
10	CAN_H	Can Bus high	bidirectional
11	COM1_TxD	RS232 Interface for firmware updates TxD	bidirectional
12	COM1_rxD	RS232 Interface for firmware updates RxD	bidirectional
13	EN_CONF#	Enable / Allow firmware update	input
14	CAN_GND	Can Bus Ground	bidirectional
15	COM_GND	Rs232 Ground	bidirectional
16	Digi_In1	Digital Input no. 1	Input
17	Digi_In2	Digital Input no. 2	Input
18	NTC_GND	Ground for NTC temperature	Input
19	Interlock_In	NC	
20	Interlock_Out	NC	
21	An_U1+	Analog voltage input no. 1 +	Input
22	An_U1-	Analog voltage input no.1 -	Input
23	An_I1-	Analog current input no.1 -	Input

Attachments

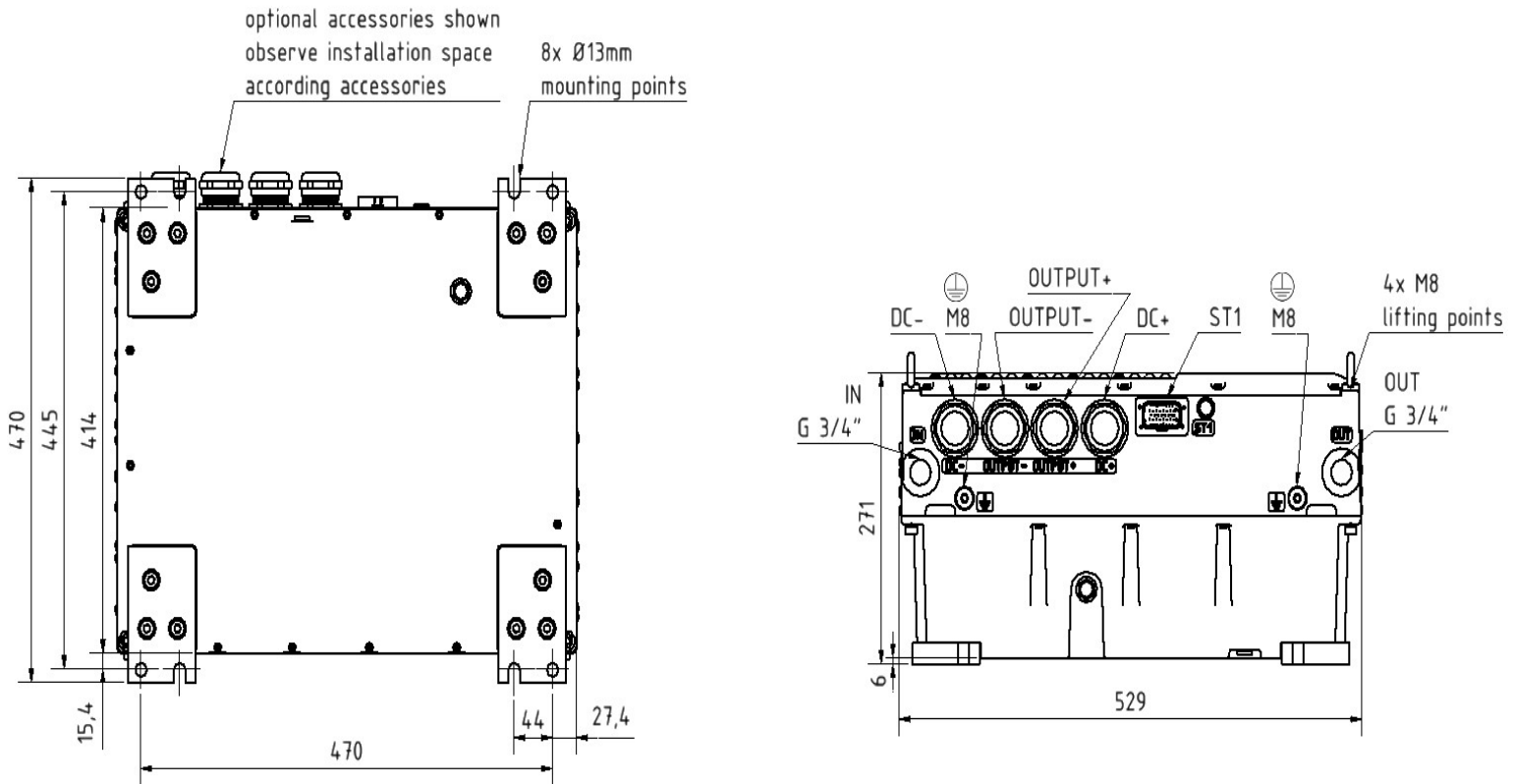

Illustration: Dimensions

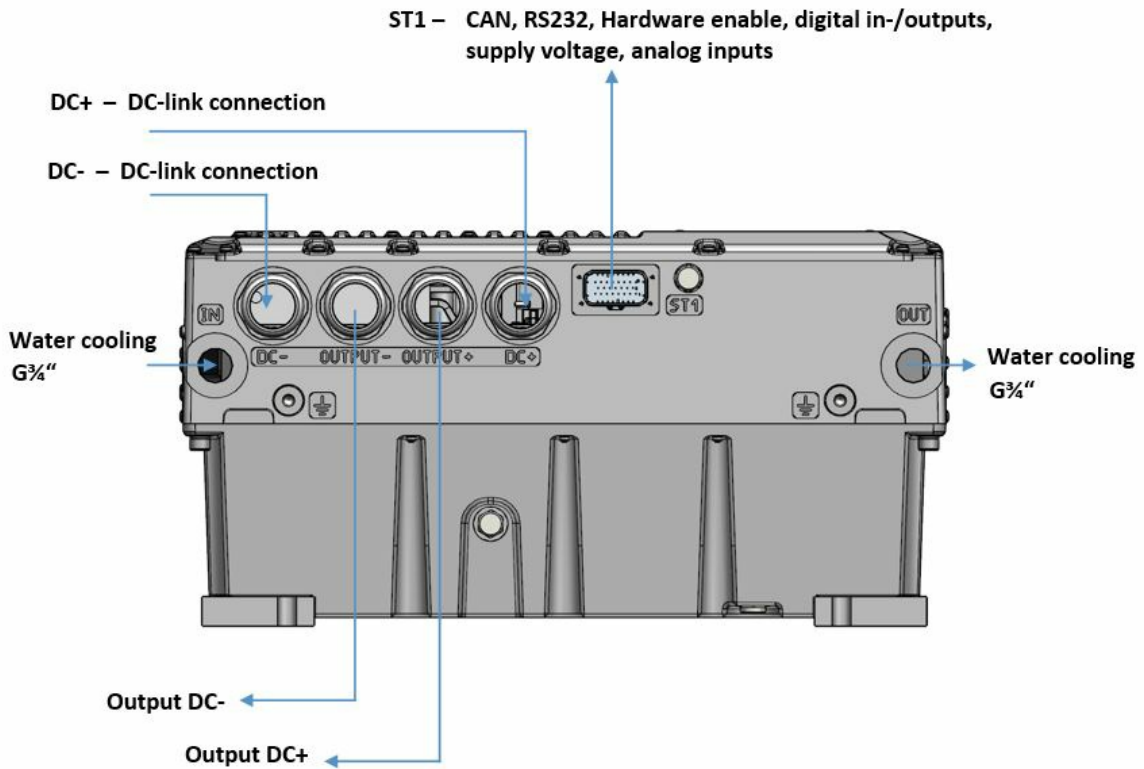
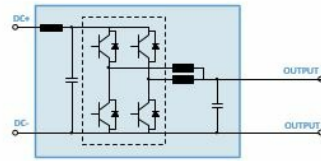
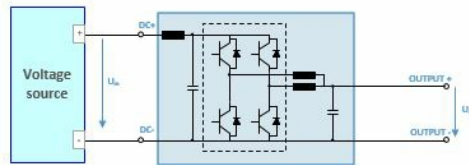

Illustration: Connectivity

Schematic Overview



Step down operation



Step up operation

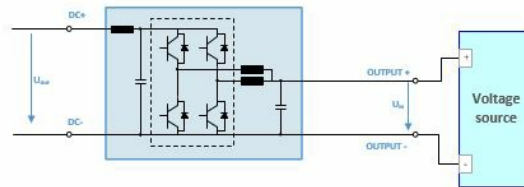

Illustration: Block diagram

VP5000-DCDC200 - Efficiency characteristics at an output voltage of 100VDC

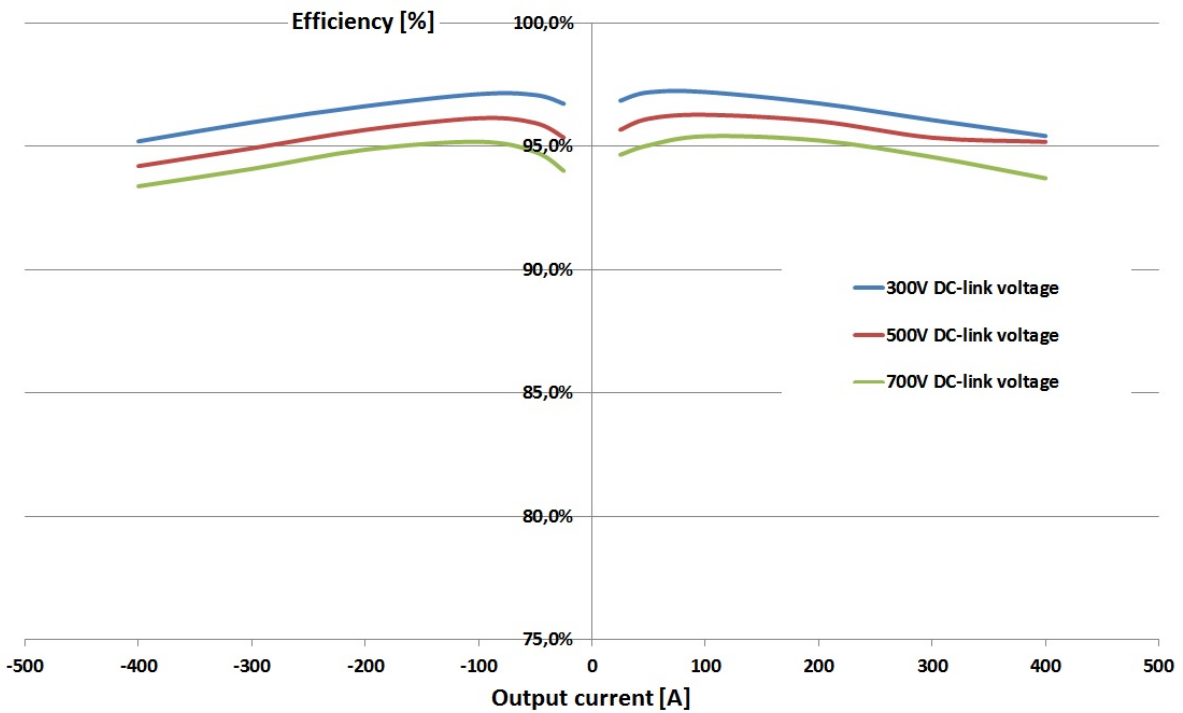

Illustration: Efficiency curves: output voltage 100VDC

VP5000-DCDC200 - Efficiency characteristics at an output voltage of 200VDC

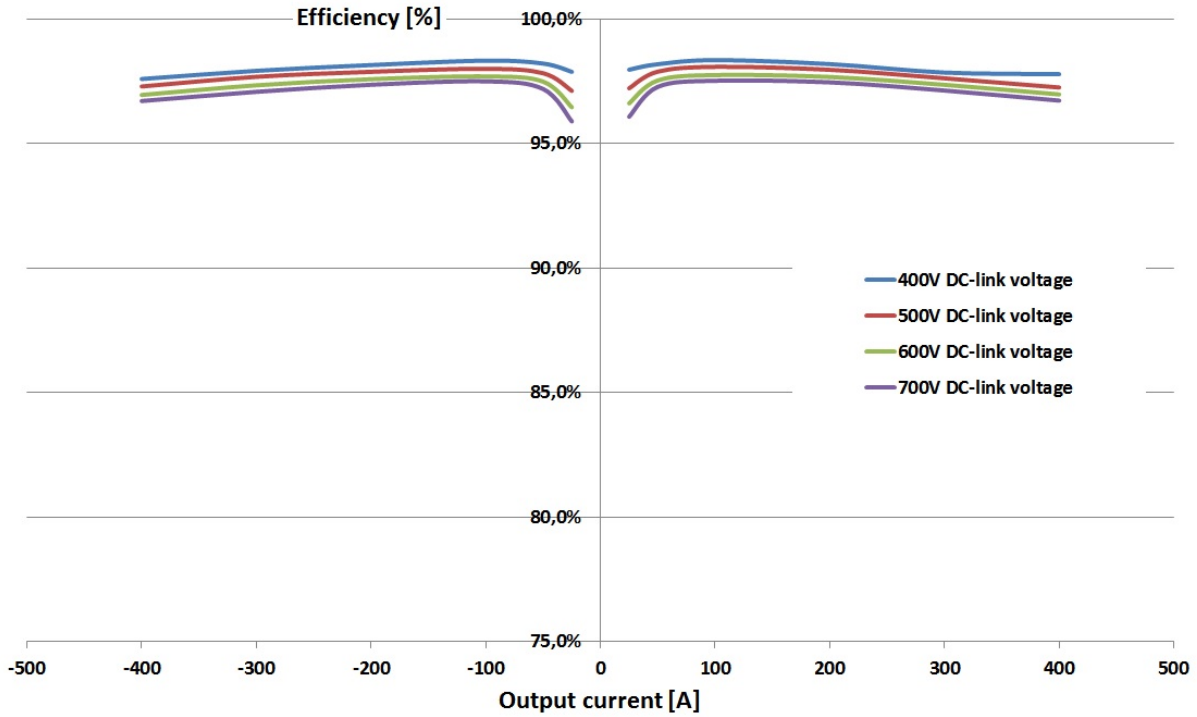

Illustration: Efficiency curves: output voltage 200VDC

VP5000-DCDC200 - Efficiency characteristics at an output voltage of 300VDC

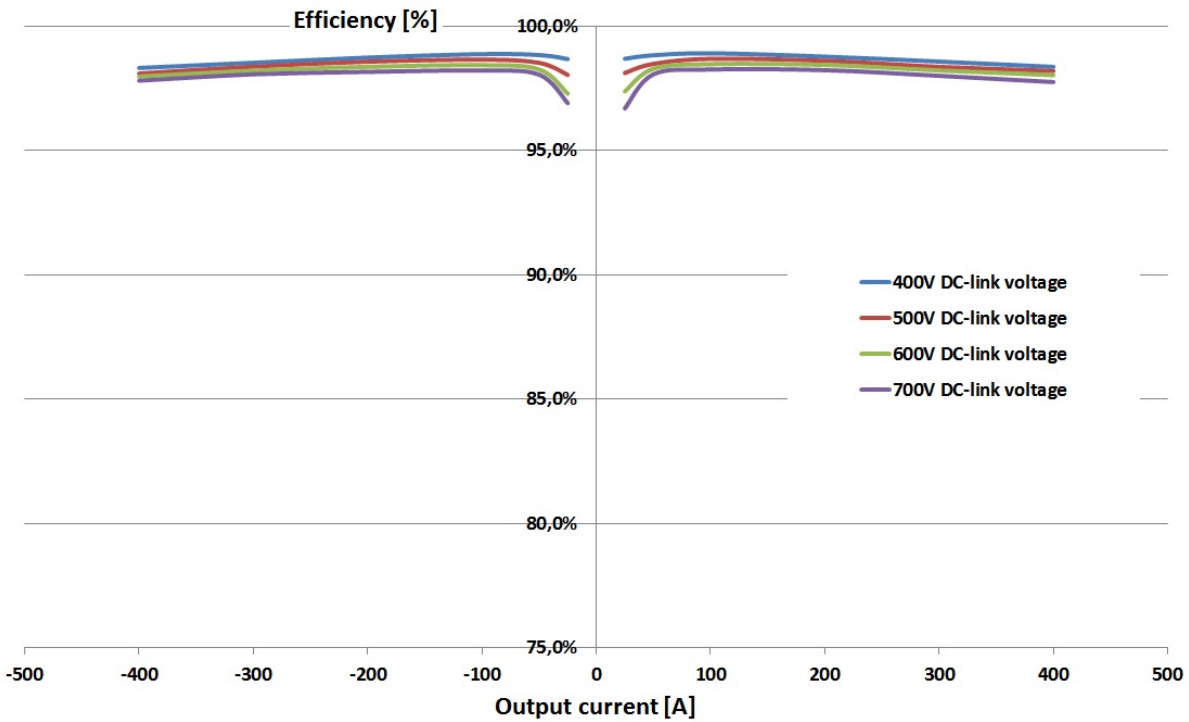

Illustration: Efficiency curves: output voltage 300VDC

VP5000-DCDC200 - Efficiency characteristics at an output voltage of 400VDC

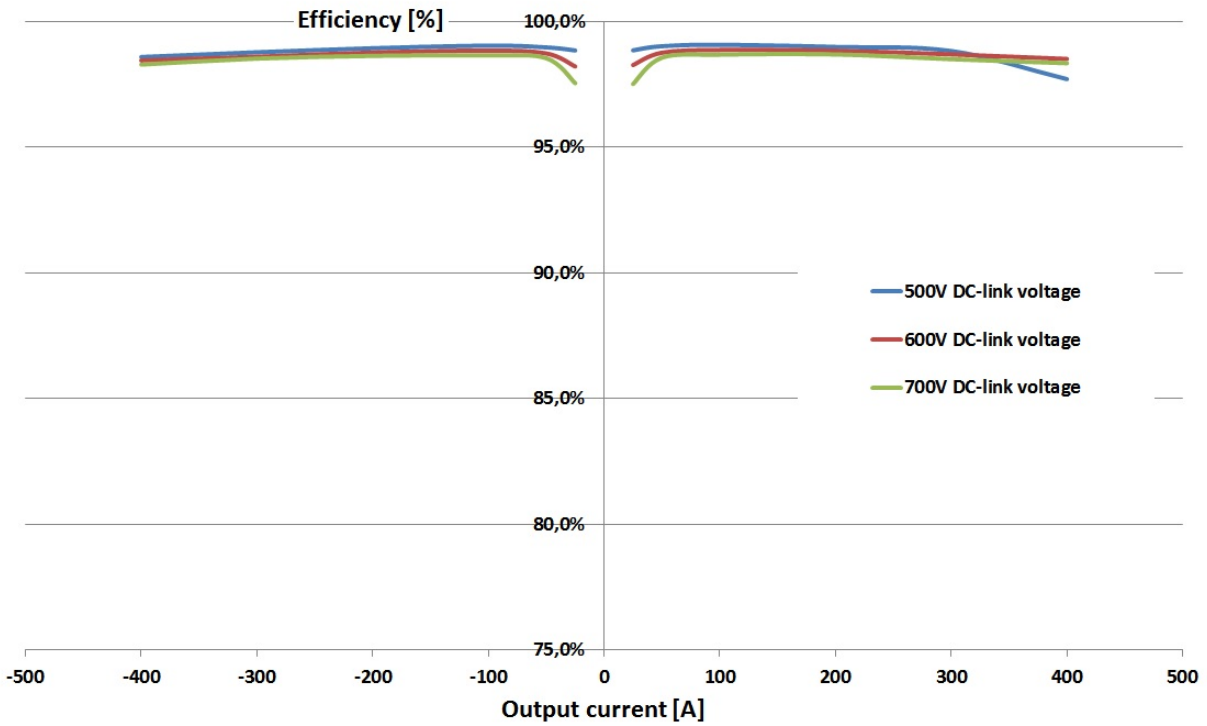

Illustration: Efficiency curves: output voltage 400VDC

VP5000-DCDC200 - Efficiency characteristics at an output voltage of 500VDC

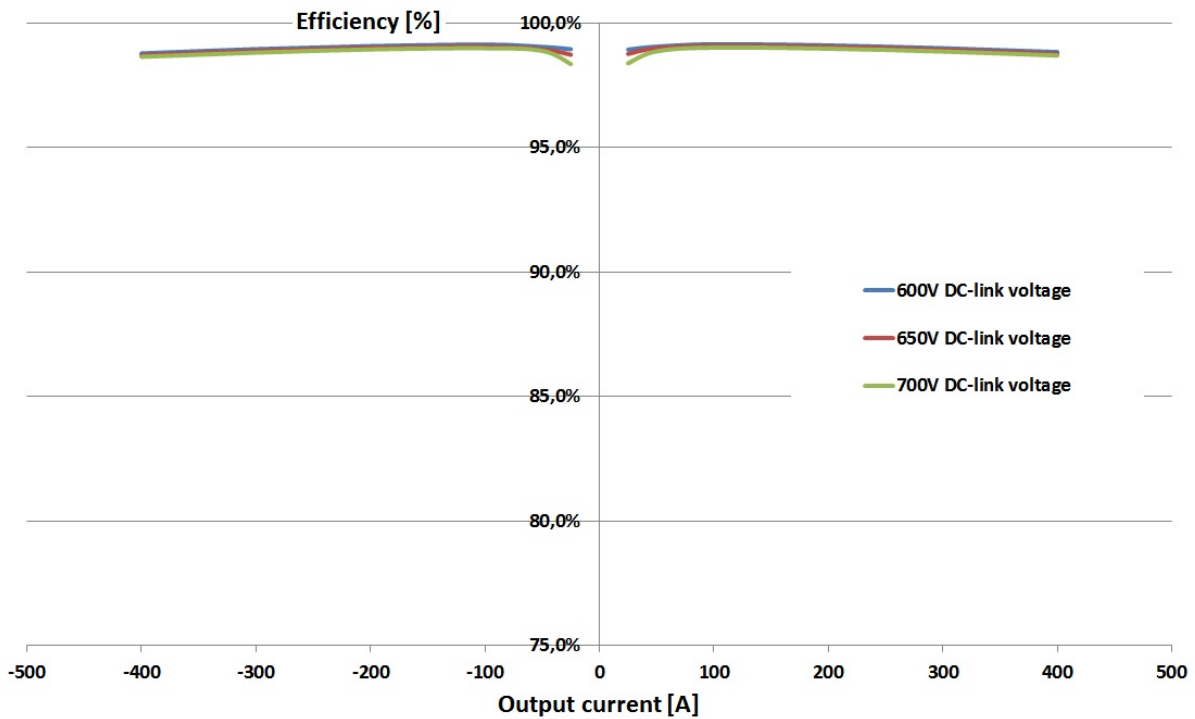

Illustration: Efficiency curves: output voltage 500VDC